

# Schéma d'implantation Boitier de commande

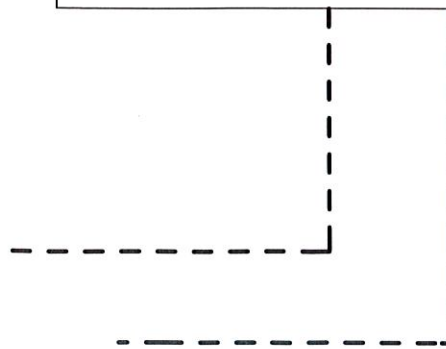

Cable vers bornier X5, X4

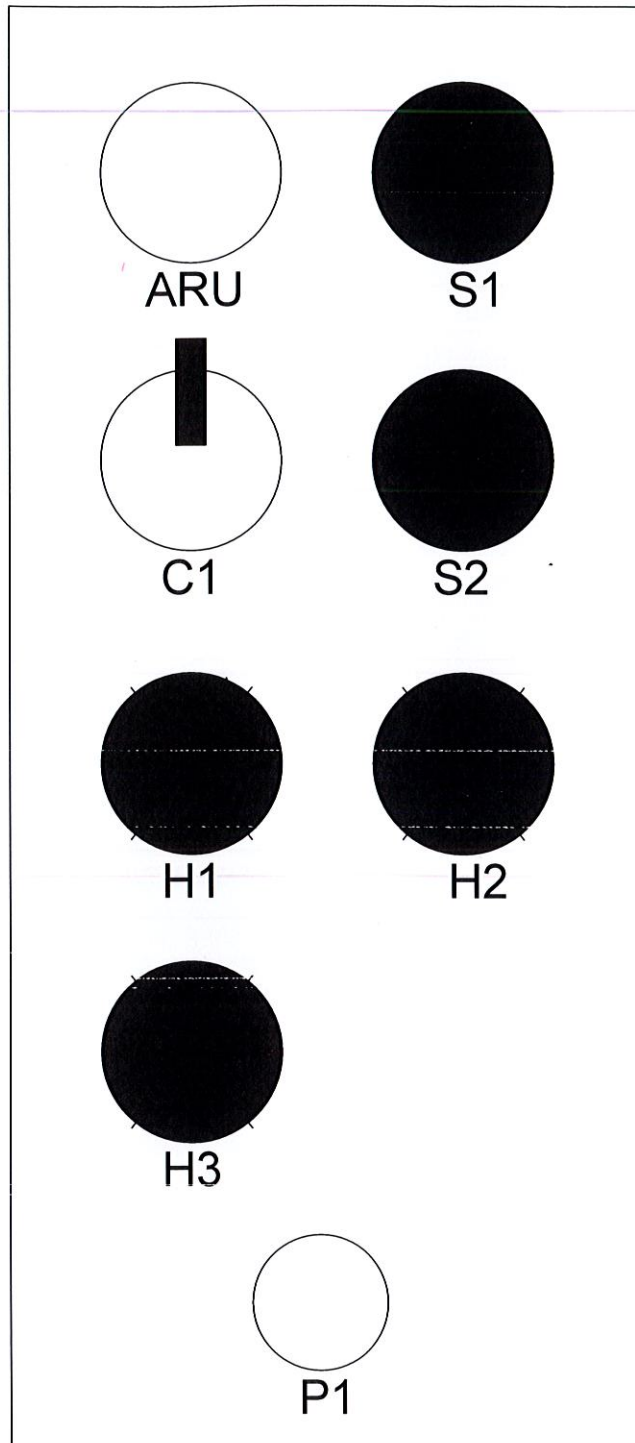
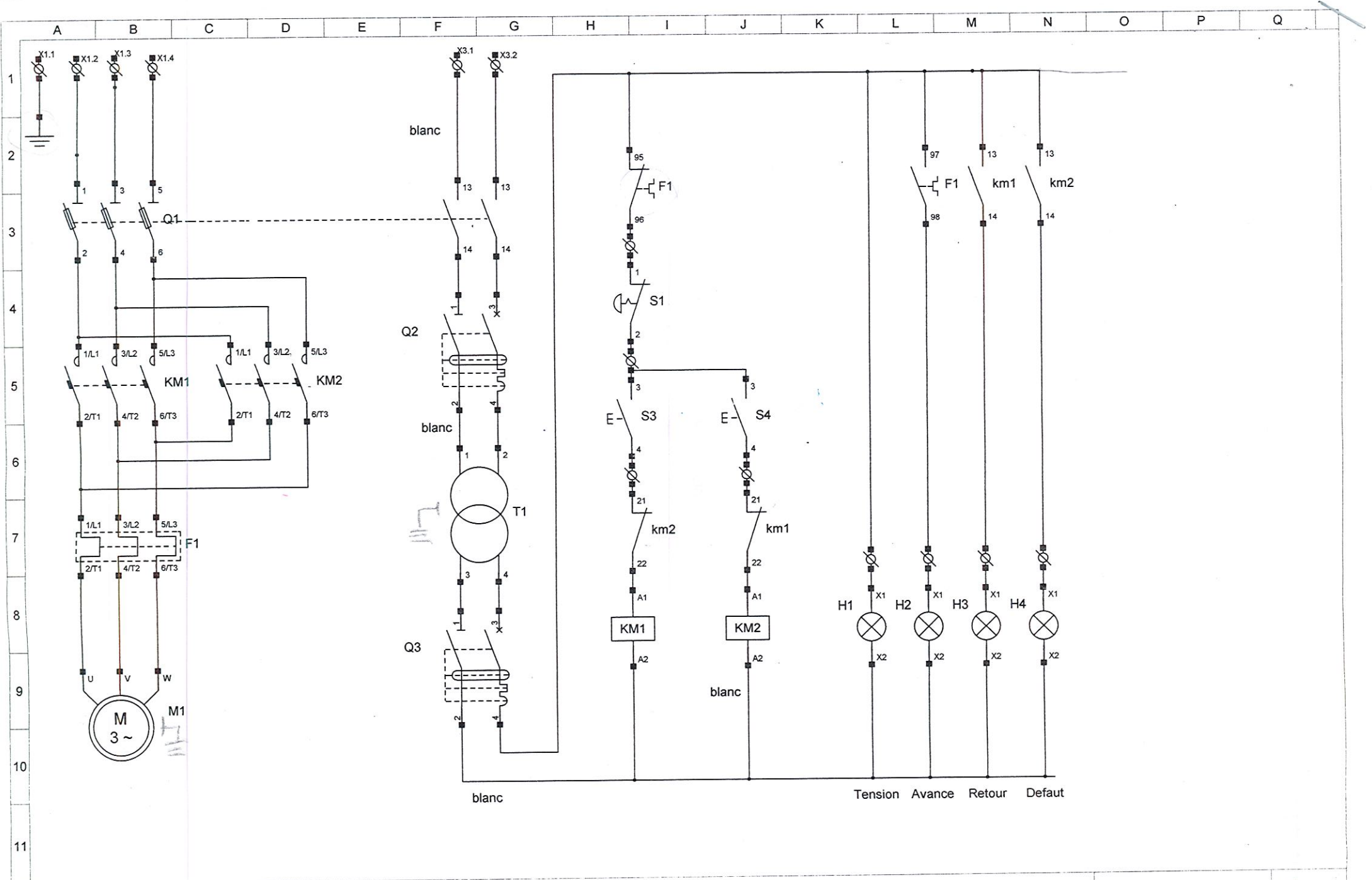

TET

Léonard de Vinci

Shéma chariot

Deux sens de rotations

Dessiné le : 28/04/17  
 Modifié le : 28/09/17  
 Par : ADAMIS

01

01

A B C D E F G H I J K L M N O

# Schéma d'implantation

ADAMIS  
TET

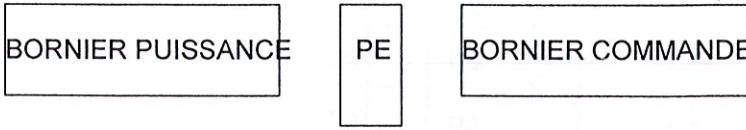
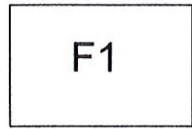
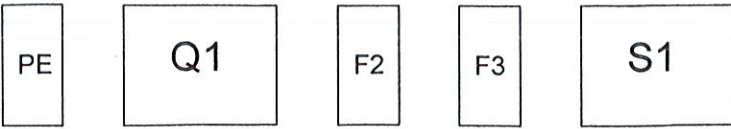

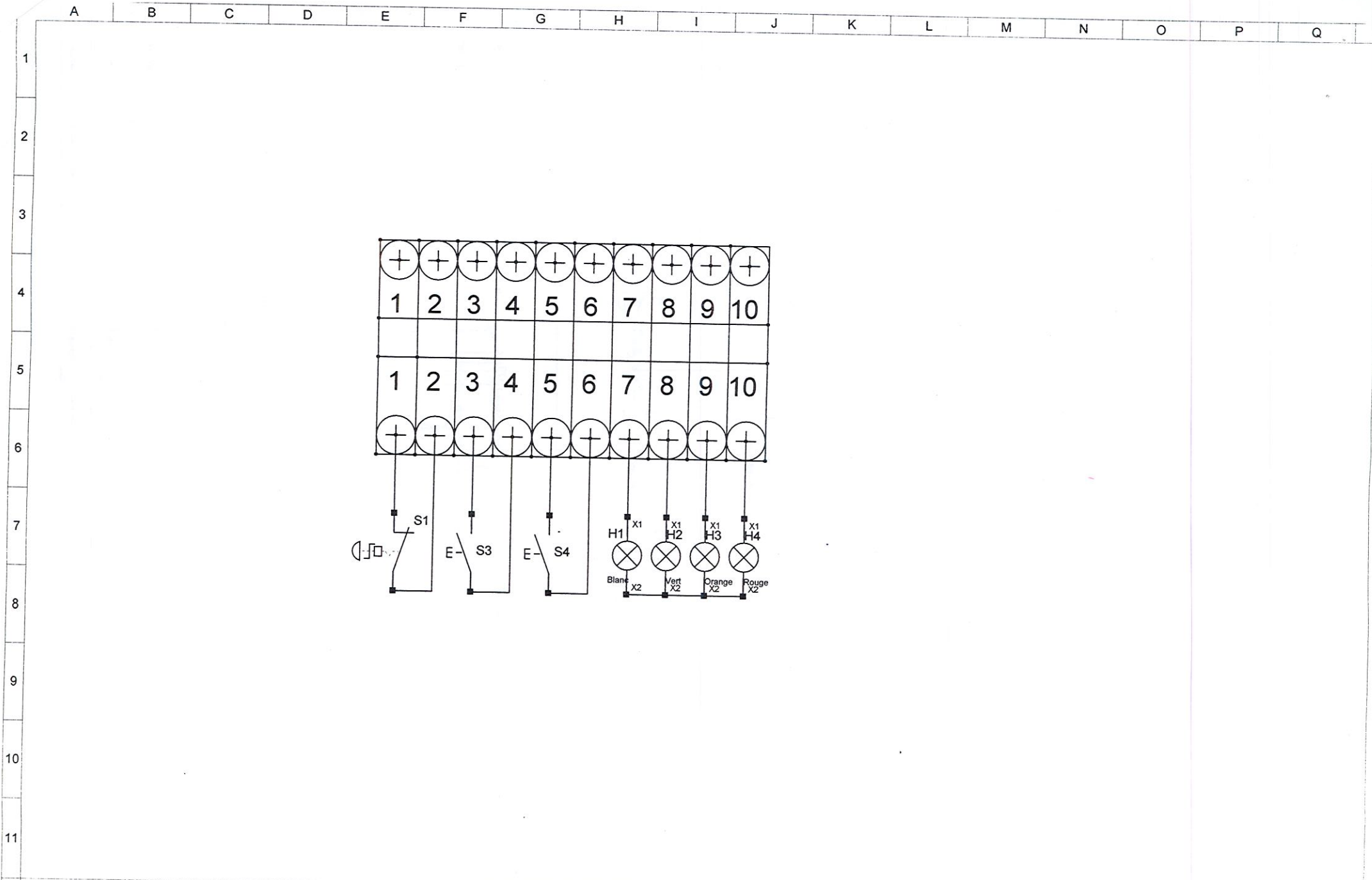

**TET**  
Leonard de Vinci

Shéma bornier de commande

Chariot deux sens de rotations

Dessiné le : 28/04/17

01

Modifié le : 28/04/17

Par : ADAMIS Madyson

01