

Circuit imprimé format 'A'

ATS1170

ATS1210/20

ATS1741

ATS1510

ATS1840

ATS7300

Circuit imprimé format 'B'

ATS1202

ATS1330

ATS1820

ATS1740

ATS1743

ATS1810

ATS7200

Circuit imprimé format 'BB'

ATS1742

ATS1806

ATS1811

Légende et exemples de compatibilité

Circuit imprimé format 'C'

ATS7100

ATS7110

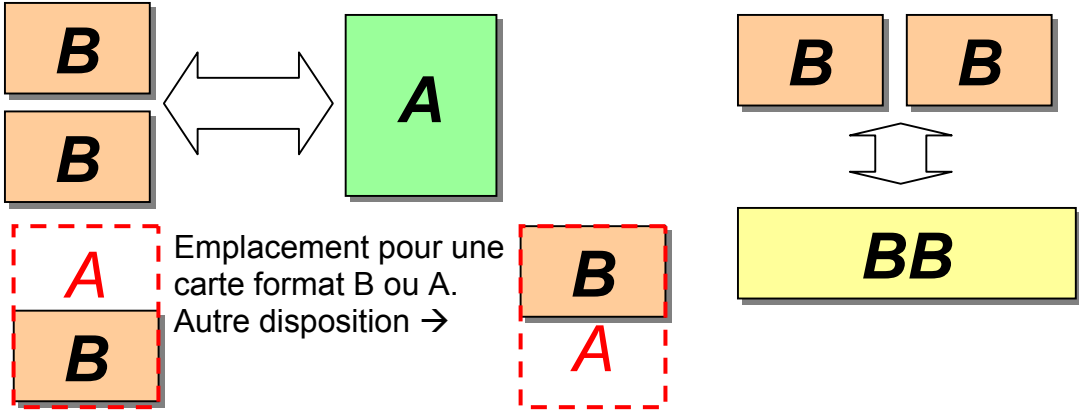

ATS 1201



Chargeur déporté

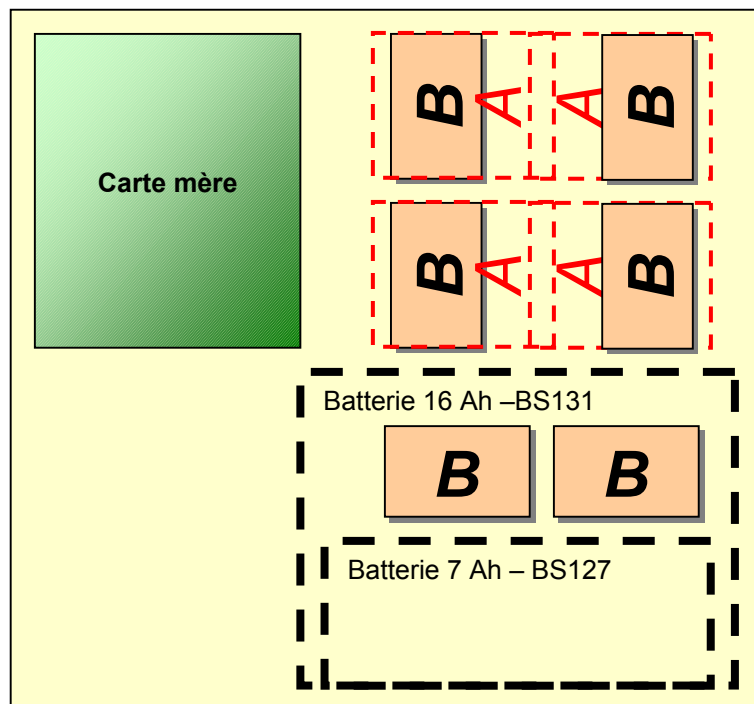

ATS 1204

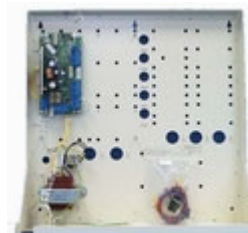

Chargeur déporté
NFA2P type 3
N° 123020-09

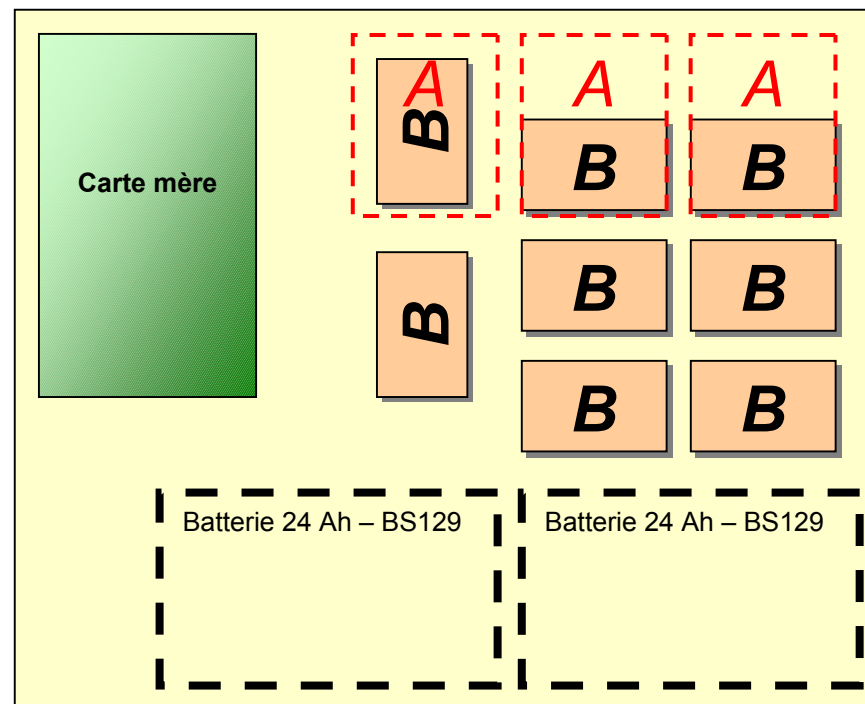

ATS 1250



Contrôleur quatre portes

ATS 2102



Centrale d'alarme
NFA2P type 2
N° 122064-00

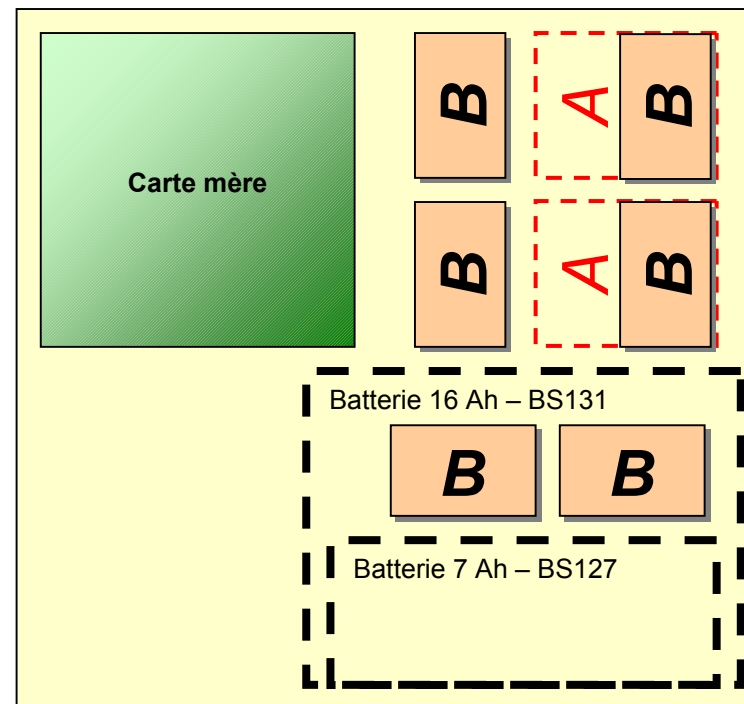
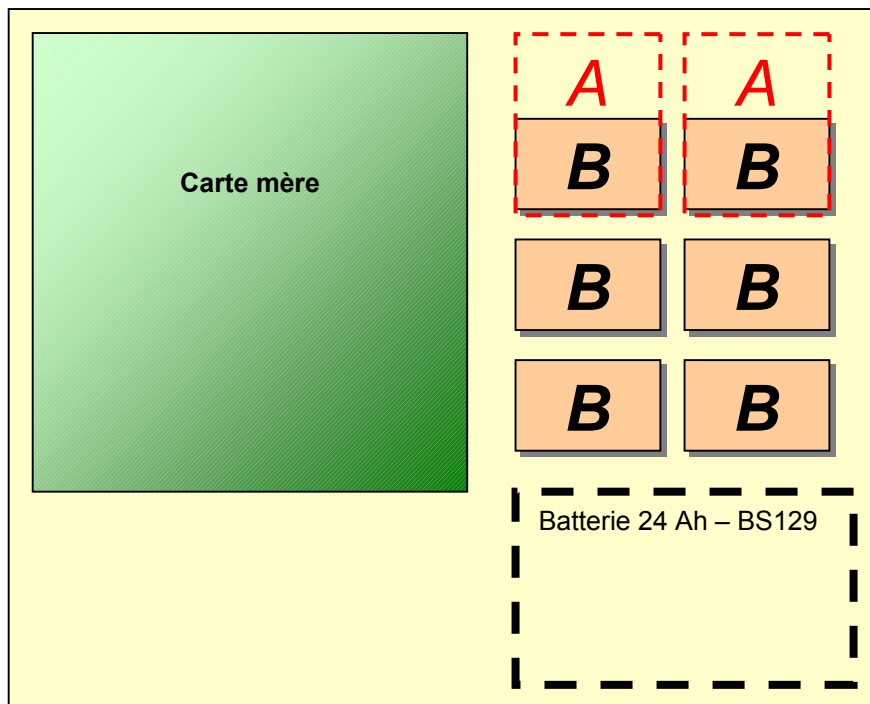

ATS 2402



Centrale d'alarme
NFA2P type 3
N° 123023-00



ATS 3402

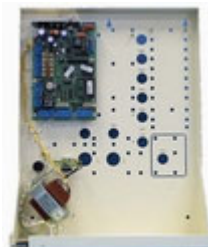

Centrale d'alarme
NFA2P type 2
N° 122060-00

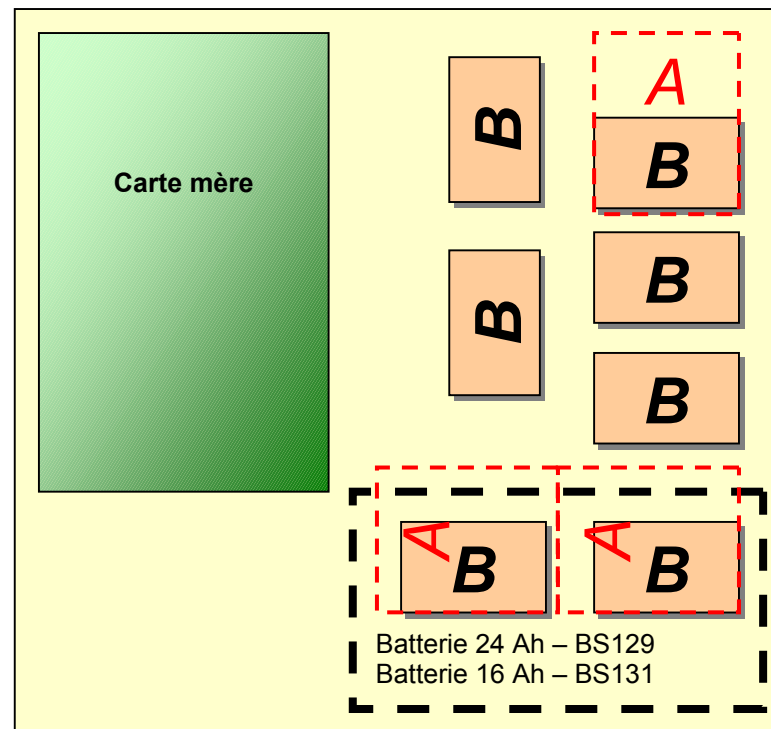
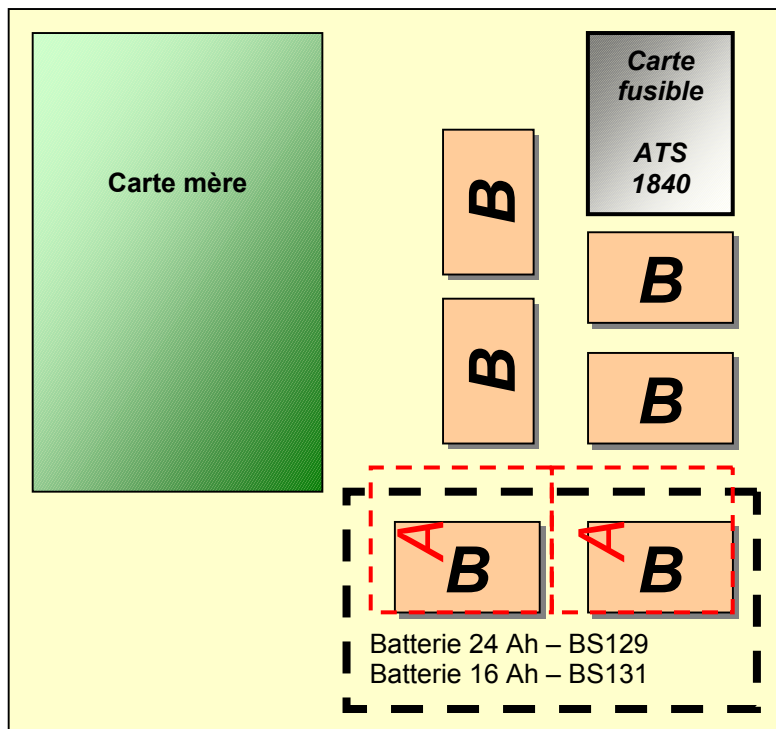

ATS 4002



Centrale d'alarme

ATS 4602



Centrale d'alarme
NFA2P type 3
N° 123020-00

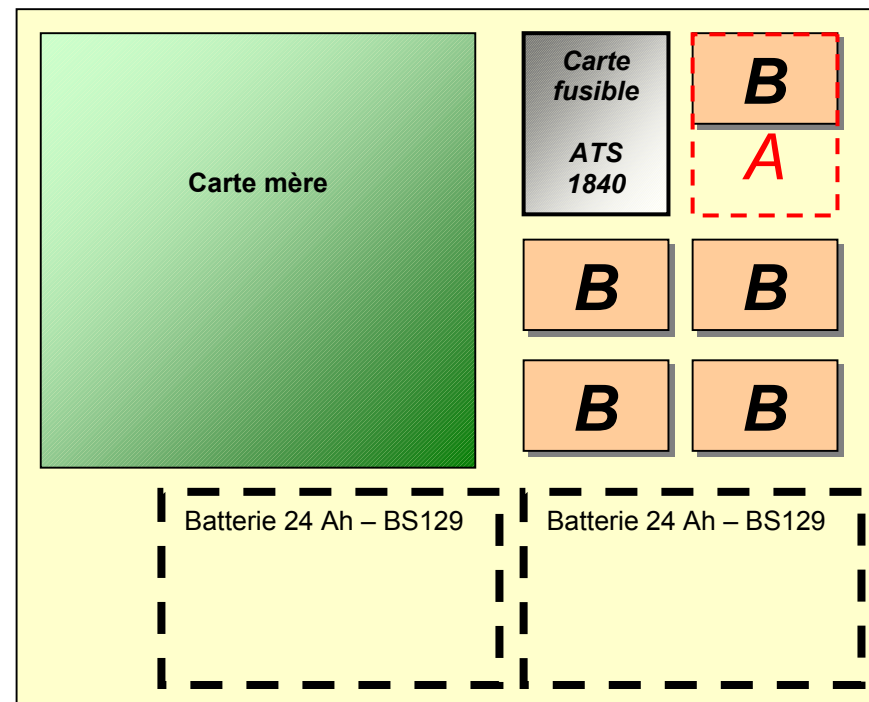
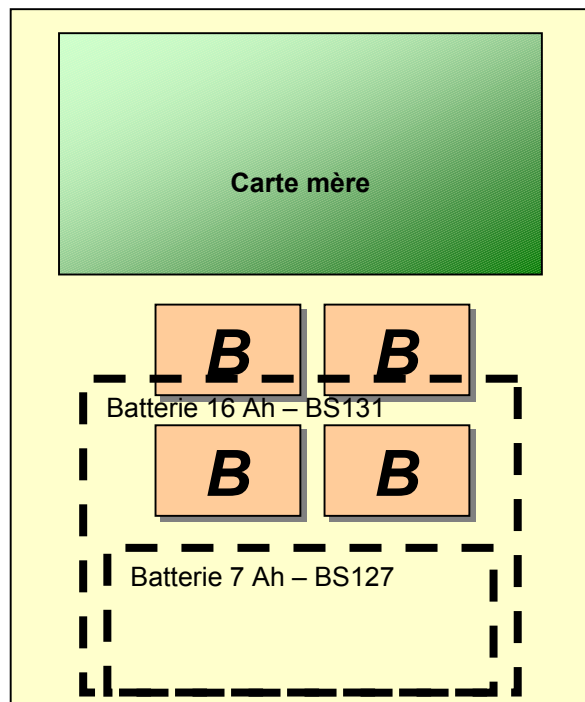

ATS 1640

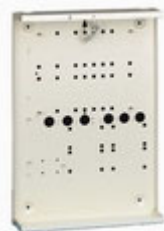

Coffret métallique vide auto protégé pour ATS4002

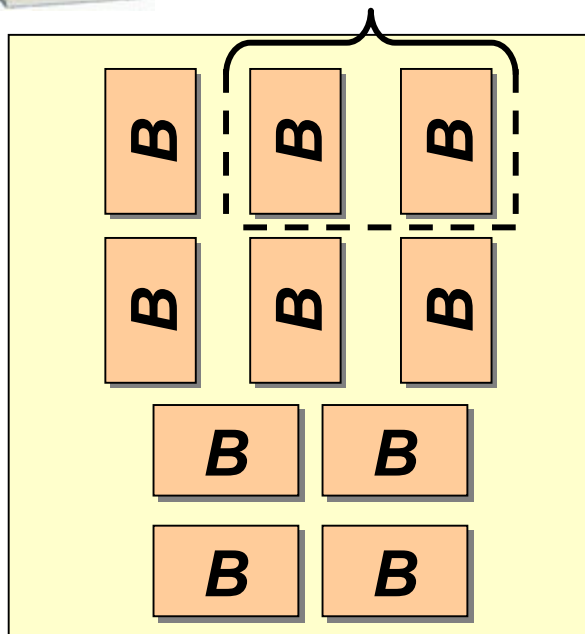

ATS 1641

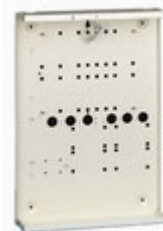

Coffret métallique vide auto protégé pour ATS1201 et ATS2102

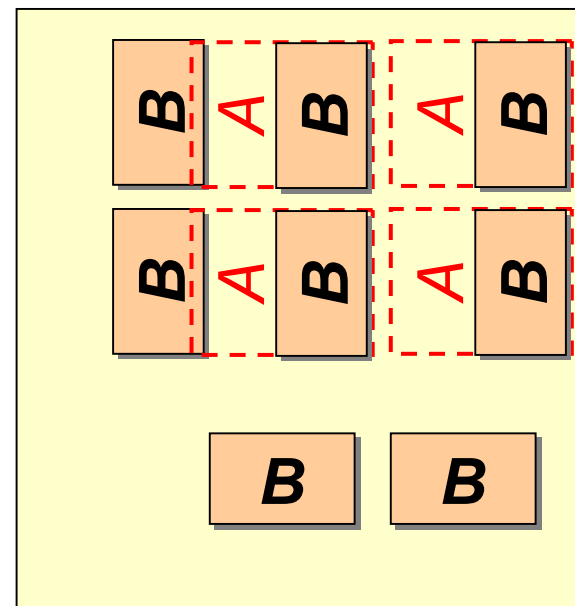

ATS 1642



Coffret métallique vide auto protégé pour ATS1250 et ATS4602

ATS 1643

